



the
**POND
SHOP**

at Van Beek's

thePondShop.ca



The Pond, Owner's Handbook

Welcome

Water Gardening Enthusiasts!

Water gardening is an old hobby that today, is the hottest trend in landscaping, nationwide.

Radical changes in product development and design concepts have converged to make today's water gardens the most beautiful, ecologically friendly, and low maintenance water features in history. However, to capitalize on the latest design trends and product advancements, you need to have a blueprint to follow for water garden success. As with any exploding industry, like water gardening is right now, misinformation and conflicting advice run rampant. This guide and owner's manual is designed to cut through the confusion and become your blueprint for success in the water gardening hobby.

You have two routes to take when getting into this hobby. The traditional do-it-yourself track, or the hiring of a landscape or water gardening professional to do it for you. This magazine contains the blueprints for both avenues.

Working with Mother Nature

The Aquascape™ products and plans are designed for the weekend warrior tackling a water garden project, and the *AquascapePRO™* products are designed and constructed for professionals or serious water gardeners. Both products and systems are designed to do one thing – create ponds that work with Mother Nature, and not against her. Only by doing that, can you truly have a beautiful, natural, and low maintenance water feature to enjoy. As you see when you flip through these pages, there's a boatload of products and information to help you succeed and enjoy the water garden lifestyle.

Inspiring and Educational

When you take the plunge with water gardening, be sure to visit www.aquascapeinc.com, a web site that contains articles on container water gardens, seasonal maintenance, installation tips, and much more! While you're there, click on the "Newsletter" link to sign up for Pondsides Monthly and receive free tips and articles in your e-mailbox each month.

All these resources ensure one thing: There is a plan to cut through the confusion, and once you get your water feature, there's going to be consistent and up-to-date support to help you enjoy your new hobby.

You Deserve It!

Don't you deserve your own piece of paradise to come home to each day? Take the plunge and join the millions of "pondaholics" who are already enjoying the hottest trend in gardening today!

The Pond Guy™

Table of Contents

4 Introduction to Pond Ecology and the Aquascape Ecosystem

Understanding your pond and how all of the elements work together to create a naturally functioning, low-maintenance water feature



6 Pond Fish

Everything you need to know about taking care of your fish



8 Aquatic Plants

The role of aquatic plants in your pond

8 Water Lilies

9 Marginals, Floating Aquatics, Submerged Aquatics



10 Pond Myths

20 top pond myths and why they are "myths"



12 Maintenance

Tips for maintaining your pond throughout the year

13 Preformed Ponds, Pondless® Waterfalls

14 General Maintenance

15 Fall & Winter Maintenance

16 Spring Maintenance

18 Top 10 Methods to Get Your Ecosystem in Balance

19-22 Pump Troubleshooting





“Backyard water features are not only enjoyable for us, but also necessary for the sustainability of our environment.”

Pond Ecology

Understanding Pond Ecology

The goal in water gardening today is the creation of a naturally balanced, low-maintenance aquatic ecosystem that allows water gardeners more relaxation time by their aquatic paradises, and less time worrying about maintenance.



environment, including the living plants and animals, water, air, and the sun's energy. Backyard ponds can function as ecosystems because they play host to a total interrelationship of all organisms in the environment – birds, fish, frogs, plants, and many microscopic organisms. These ponds not only create a natural ecosystem in their defined environment, but they also fit into the community or life cycle of not just one backyard, but of the entire ecological region.

The Big Picture

We should remember that our backyard water features are not only enjoyable for us, but also necessary for the sustainability of our environment. Do you want your pond to be more diverse? Given a little time and proper plant selection in and around your pond, you can create a very diverse ecosystem in your yard. Just remember to keep it simple and, with patience, your pond will mature over the years into a beautiful and functioning part of nature.

One Pond Makes a Difference

One pond in one backyard may not seem very important, but when you have a thousand similar backyard ecosystems functioning simultaneously, there truly is a positive impact being made on the environment. These water features help provide an oasis for creatures whose natural habitats have been replaced by development – birds, frogs, toads, newts and salamanders, and many others whose numbers have been declining sharply for many years now.

So at a grassroots level, as the hobby of water gardening grows, there are additional habitats and diversity being added to our stressed suburban environments. ■



Given a little time and proper plant selection in and around your pond, you can create a very diverse ecosystem in your yard.

The Aquascape Ecosystem

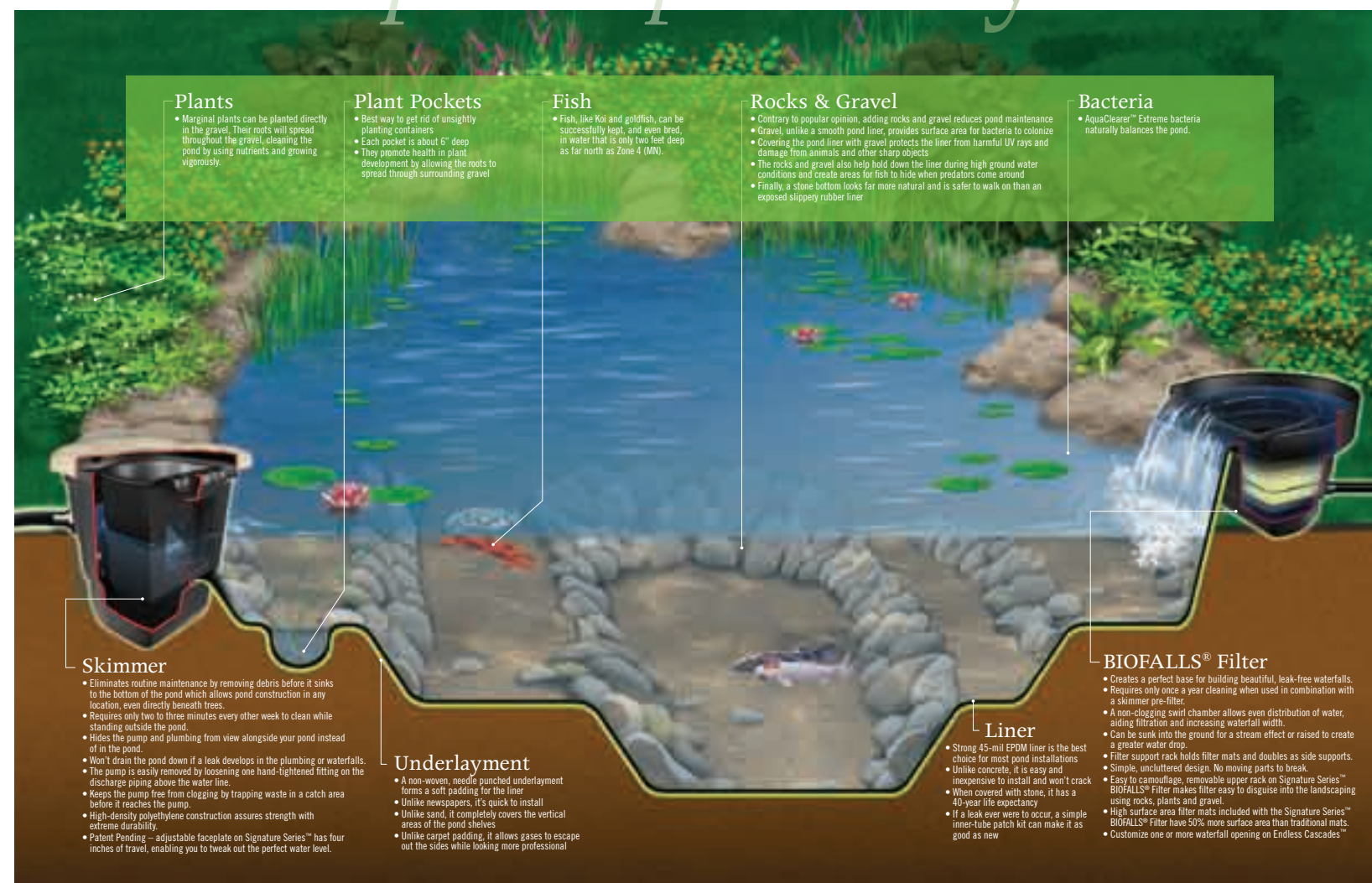

Pond Fish

The Jewels of the Water Garden

Koi ... the jewels of the water garden! Have you thought about making them a part of your watery paradise?



ABOVE: Fish are a major part of your pond's ecosystem. They are important to your pond's overall health, but they also make great pets.

Everyone who has koi preaches of the joy they have while feeding them, watching them swim through caves and waterfalls, and even naming them. You'll find koi of all different shapes and sizes named accordingly. There's "Goldie" – everyone's favorite yellow fish; and "Spot" – the fish with a precarious spot on the front of its forehead; the names can go on, and on, and on!

Low-Maintenance Pets

One of the other things that is so wonderful about welcoming a fishy friend into your pond is that they are pretty low-maintenance. You won't see a koi scratching at the door to go for a walk, or choosing your prized sofa for a litter box. Nope. Fish live, breath, and eat in the exact same place...your pond. They truly are one of the most low-maintenance pets you can have.

When it comes to feeding them, you may notice that there are several different recommendations

out there. If your fish are part of a balanced ecosystem, as is the case with an Aquascape pond system, your best bet is to feed them as much as they will eat in five minutes, being careful not to leave too much food floating at the surface.

Fish can also over-winter in your pond, so you can rest assured that they won't be in a tub in the middle of the living room as the months get colder. After all, they won't even pay rent!

More Than Just Koi

Are there other fish, besides koi, that make great pond-living pets? There most certainly are! That same goldfish that stares at you from the glass at the fish store is a perfect fit for your pond. Goldfish are incredibly resilient and can be a great starter fish for a new pond. Best of all, they come in all shapes, sizes, and colors and if you have a container water garden or preformed pond, they're a great fit!

Another fish that is sure to find its way into your heart resembles the koi, but is much smaller. It's called a shubunkin and it's a kind of single-tailed, long-bodied goldfish that differs from the koi in the fact that it doesn't have "barbels," which are whiskers of sorts, that are used to root through gravel.

It Doesn't End There

If you do your homework, you'll find that there are plenty of fish (many native to your area) that would be perfectly content in your pond. From minnows to mosquito fish, to carp and game fish – your options are endless. Fish are a major part of your pond's ecosystem and they are important to your pond's overall health, but they also make great pets. And best of all, regardless of what's happened in your life, they'll always be there to greet you at the end of a long day. Ain't that grand!?

TYPES OF COMMON POND FISH

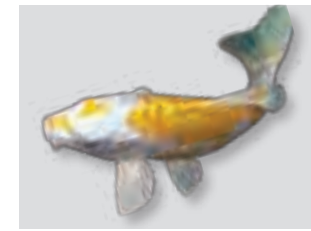

KOI



GOLDFISH



SHUBUNKIN

FISH FOOD



Aquascape Premium Staple Fish Food

Scientifically formulated to provide premium nutrition to all pond fish. Contains high quality protein.



Aquascape Premium Cold Water Fish Food

Scientifically formulated to provide premium nutrition to all pond fish at colder water temperatures.



Aquascape Premium Color Enhancing Fish Food

Scientifically formulated with the inclusion of Spirulina, Krill meal and Astaxanthin which helps to promote brilliant fish color.



Aquascape Fish Food Flakes

Premium nutrition in a flake so that it can be consumed by the smallest of pond fish.

Fishy FAQs

How is my koi different from a goldfish?

Simple. Have you ever seen a goldfish with whiskers? A koi's whiskers are called barbels and are used to root around in the gravel or mud for food.

Will other animals eat my fish?

Yes. Unfortunately, heron, owl, raccoons, and others find koi and other fish quite delectable. Make sure your fish have a place in your pond to hide, whether it is plants or large crevices. If those animals get to be a problem, a Scarecrow water sensor or Heron Decoy may be the answer.

What do I feed my fish?

Koi food is available at most pet shops or online. There are many types of food on the market today, and those in pellet form seem to be the most popular. The Koi Balance™ line contains koi food for every need (see chart above). Fish also like to feast on yummy treats like fresh fruits and veggies.

How many fish can I put in my pond?

A good rule of thumb is to allow one inch of fish for every square foot of pond surface area, and to remember – fish grow! This rule cannot be applied to fish greater than six inches long because weight and girth may play a big factor.

Can fish get sick?

Like all of nature's creatures, fish can fall ill due to diseases, ulcers, parasites, and fungus. Aquascape offers several medications for your finned friends under the EcoRx™ line. There are also preventative medications like EcoRx™ Pond Salt to replace natural electrolytes for improved fish health.





Aquatic Plants

The Role of Plants in a Water Garden

Aquatic plants aren't just used in the water garden to provide beauty and naturalization...

They also serve the very important function of helping to balance the pond ecosystem. Their valuable biological filtration helps remove nitrogen, ammonia, nitrates, and other minerals that algae would otherwise feed on. In addition, the plants provide food, shade, and protection for the fish and wildlife that live in and around the pond. Typically, they are divided into four groups – water lilies, marginals, floating plants, and submerged plants.

Water Lilies

Water lilies are available in hardy and tropical varieties. They both come in a wide variety of colors, shapes, and sizes and the leaves

provide fish with shade from the heat of the summer sun, cooling the water and making algae control easier too.

Hardy

Hardy water lilies are reliably perennial from the northern reaches of Zone 3, to the subtropical areas of Zone 11. The white, pink, red, or yellow flowers float directly on the water surface and are open during the day. When cold weather comes, the foliage dies. This should be removed before winter. New leaves emerge again in the spring.

Tropicals

The flowers of tropical water lilies sit above the water and come in the typical whites, yellows, pinks, and reds. Unique to tropical water lilies are the blue shades – light blue to deep purple. Flowers are also more often fragrant and there are varieties available that bloom at night.

Although tropical lilies are only hardy to zones 10 and 11, they can

be planted in colder zones when the water temperature is consistently above 70° F and treated as annuals or over-wintered, if given proper care.

To Pot or Not?

Go natural when planting your water lilies – hide those pots! Planting pockets help you do this. Hopefully these have been excavated into your pond, if not, you can create them with rocks right on the liner. Place the potted lily into the pocket and cover with rocks to hide the pots.

Fertilizing

Fertilizing water lilies is necessary to encourage a greater number of larger flowers. Time-released, granular fertilizer, mixed into the soil at the bottom of the pot or plant pocket, is a great way to fertilize lilies at the time of planting. Any other time, however, it would be messy and inconvenient. That's when EcoSystems® EcoTabs™ fertilizer tablets work great.

Marginal Aquatics

Marginal aquatics are the plants found growing around the edges (margins) of a water garden. They add valuable filtration to the pond and they remove elements that would otherwise feed algae.

To create a natural-looking pond, a good selection of marginal plants is very important. There are hundreds of varieties – hardy and tropical – that come in all shapes, sizes, textures, and flower colors.

PLANT CONTAINERS



TIP: Keep overly-aggressive plants, such as lotus, in their containers to keep them from spreading uncontrollably through the pond.

How to Plant Marginals

In a rock and gravel pond, marginal plants are generally placed directly into the gravel. This allows them to thrive naturally, and filter the water more effectively. Invasive species should be kept in pots that are buried in the rocks and gravel. Well-behaved plants can be taken out of the pots and planted directly in the gravel where the roots can absorb nutrients directly from the substrate of the pond where fish waste and other organic debris settle and begin to decompose.

Choose the area for the plant, move the gravel aside with your hands, place the plant, and spread the gravel around the base to support the plant and hide the pot. If you're planting bare-root, remove the plant from the pot and wash away any loose soil before planting. Tropicals that you plan to bring indoors over the winter, should be left in the pots to make removal easier.

TYPES OF COMMON AQUATIC PLANTS



HARDY WATER LILY



TROPICAL WATER LILY



LOTUS



Taro – MARGINAL AQUATIC



Water Hyacinth – FLOATING AQUATIC



Water Lettuce – FLOATING AQUATIC

Floating Aquatics

Floating aquatic plants sit on the water surface while their roots hang down into the water. Most are tropical, but a few are hardy perennials in climates with hard winter freezes. These plants may be used to shade the water, helping with summer algae control.

Plants such as hyacinth and water lettuce do a great job of disguising the open top of the BIOFALLS® filter, while providing excellent filtration. Use a stick across the spillway to keep the waterfall from carrying the plants over and into the pond. They can also be floated in the pond, however care must be taken to make sure that they don't end up in the skimmer.

Submerged Aquatic Plants

Submerged plants are commonly referred to as oxygenators, but this is a false description. These plants do produce oxygen during the day, but at night and on cloudy days, the cycle is reversed and they use oxygen and produce carbon dioxide. These plants are still important allies in creating a well-balanced water feature by using nutrients in the water. They also provide great hiding places for baby fish.

The Added Touch

Aquatic plants will add a new dimension to your water feature. If you take the time to learn a little about them and their requirements, you'll find them easy to install and care for. They come in many forms and sizes, varying widely in their environmental needs. It is highly likely that, for any given situation, you can find several species of aquatic plants to fill the bill. To learn more about aquatic plants, grab a copy of *The Hobbyist's Guide to Pond Plants*. Ask your local retailer or pond professional. ■



ABOVE: Learn everything you need to know about types of water garden plants.

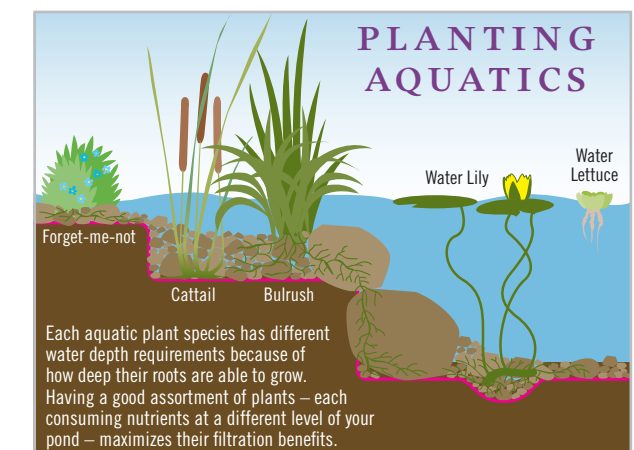

AquaScape Aquatic Plant Fertilizer



*“Why believe us?
We have over
15 years of field
experience building
and maintaining
water gardens!”*

Pond Myths

Common Ponderings

I want my pond located in the lowest part of my yard.

This is probably the worst location for your investment because of the run-off that can creep its way into your pond. When your pond is positioned near your house, you can take in the beauty and tranquility of your pond when entertaining friends or lounging on your deck.

You can use a timer on your pond pump.

Not true! Your pond is a living, breathing ecosystem that needs constant oxygen, just like the human race. If you shut your system down at night, then you can never have sufficient growth of beneficial bacteria to fight algae blooms, and your finned friends will have a hard time breathing. You can shut down a Pondless® Waterfall system, however, whenever you'd like because there is no ecosystem depending on the circulation.

It's necessary to drain and clean your pond regularly.

If you decide to work in harmony with Mother Nature instead of doing battle with her, then draining and cleaning your pond should take place only once a year (at most). Clean-outs should occur in the spring.

The more filtration, the better the pond.

Believe it or not, you can over-filter a pond. Tight filter pads in your skimmer pick up the smallest particles of debris, requiring you to constantly clean the filtering mechanism. If you can see a dime on the bottom of the pond, then the water clarity is just right for your fish and filtering past that creates headaches, instead of eliminating them.

You can't be a koi hobbyist and a water gardener.

You can raise koi and have a beautiful water garden. The koi can grow up to be just as beautiful

and just as healthy as they are in traditional koi ponds – and you'll love them just as much!

Predators will eat all of your fish!

Fortunately, most fish will swim to a deeper, more protected part of the pond when a predator is threatening them. The Scarecrow, a motion-sensing sprinkler that can be set up alongside your pond, ready to fire a steady stream of water at a heron, has had some degree of success in warding off these curious critters. Plenty of lily pads or even some pond caves give the fish some protection and will work to minimize attracting a heron in the first place.

The presence of rocks and gravel makes it difficult to clean your pond.

Rock and gravel bottoms offer a natural place for aerobic bacteria to colonize and set up housekeeping. This bacteria breaks down the



fish waste and debris that would otherwise accumulate in the pond and turn into sludge.

UV lights such as those in the UltraKlear™ UVC are the best way to keep your pond water clear.

UV clarifiers are one of the ways to keep your pond water clear, but certainly not the only way, and arguably not the natural way. The fact of the matter is that if you have a pond that's naturally balanced, you don't need a UVC at all.

Your pond must be at least three-feet deep in order to keep koi.

There are thousands of two-foot deep ponds around the country, full of happy and healthy koi.

The water in a two-foot deep pond will generally only freeze eight inches down, even in the coldest of climates, because of the insulating qualities of the earth that surrounds the pond.

ABOVE: Rock and gravel bottoms offer a natural place for bacteria to break down waste and debris.

Koi can't be kept in a pond that also contains plants.

In a naturally balanced ecosystem, koi and plants complement and need one another. In nature, fish feed on plants. As a result, the fish produce waste, which is broken down by aerobic bacteria on the bottom of your pond, which, in turn, is used as fertilizer by the plants to grow and produce more natural fish food.

You have to bring your fish inside for the winter.

Fish do fine during the coldest of winters as long as you give them two feet of water to swim in, oxygenate the water, and keep a hole in the ice with a de-icer, allowing the naturally produced gasses to escape from under the ice.

Your pond water must be tested on a daily basis.

Mother Nature never tests her water, and her ecosystem does just fine. A

well-conceived, naturally balanced water garden normally requires no testing either.

A pond in your backyard means you will have a lot of mosquitoes.

Mosquitoes will generally only lay their eggs in still, stagnant water. If the mosquitoes happen to lay eggs in your pond and the mosquito larvae hatch, the fish in your pond will consider them a treat and will pick them off the water's surface with great enthusiasm.

You cannot have a pond in an area where there are a lot of trees.

Yes, you will have more leaves in your pond in the fall but, by the same token, the shade provided by the tree(s) will help minimize the algae bloom in the summer. If you have a skimmer sucking the top quarter inch of water off the top of your pond, it will pull most of the leaves and related debris into the skimmer net.

Having a pond may decrease the value of your home!

Everyone knows when it comes to the resale value of your home, a swimming pool can be deadly. However, in the opinion of some real estate agents, ponds can be a great addition to your home that might even pay dividends.

I have liability or safety concerns!

It's natural to have these thoughts and concerns, but it is important to remember that a professionally-installed water garden has steps leading into the pond. The first shelf is only ankle high once the gravel is laid down. The next shelf is up to your knee, while the smallest area in the bottom is just above your knee, so it is not constructed like a swimming pool. If liability is still a concern, consider the option of a Pondless® Waterfall. ■



Maintenance

Maintaining Your Pond All Year

Now that you've decided to dive into the world of water gardening, you're probably wondering exactly what you need to do to maintain your new aquatic beauty, and keep it looking good.

There is a lot of conflicting information out there about the dos and don'ts of water garden maintenance, so your head may be spinning, wondering which steps are necessary and which ones aren't. The whole point of installing your pond in the first place was to reduce the stress in your life, not add to it.

Allow us to share a little bit of water gardening knowledge with you ... the key to a low-maintenance water garden is to keep your new ecosystem in balance! Read on and learn how to water garden the low-maintenance way. Regardless of which type of water feature you own, we'll tell you the best way to maintain it with the least amount of work on your part!

“the key to a low maintenance water garden is to keep your new ecosystem in balance!”

Different Pond Types Ecosystem Ponds

The key to keeping an all-natural water garden in check is general ecosystem maintenance. The five elements of your ecosystem all need to be balanced in order to ensure that everything is working smoothly. They are:

- Mechanical and Biological Filters
- Pumps and Plumbing
- Rocks and Gravel
- Aquatic Plants
- Fish

These elements must all be present in order for the system to really work. Once your pond is balanced, it's not hard to see why maintaining a well-balanced ecosystem is easy. With the exception of some seasonal maintenance, all you really need to worry about is tossing a little beneficial bacteria into your pond and cleaning out your skimmer net once every week or two.

Preformed and Container Water Gardens

When it comes to preformed and container gardens, maintenance is a little different. There are a few products that can be used when problems arise. Remember, the smaller the system, the harder it is to achieve balance, so a more repeated dosage of beneficial bacteria may be necessary.

- **AquaClearer™ Extreme Dry** is effective at reducing sludge, waste and excess nutrients.
- **AquaClearer™ Extreme Liquid** is effective at reducing ammonia, nitrites and excess nutrients.
- **EcoFoam Away™** Removes foam from the water.

- **EcoFloc™** clumps suspended particles for easy removal.
- **EcoBlast™ Granular Algaecide** is Aquascape's #1 treatment for breaking down algae! Fast Acting and not temperature sensitive. 100% safe for fish.
- **EcoStarter™ Plus Liquid** removes & detoxifies chlorine; removes & detoxifies ammonia; destroys chloramines; detoxifies copper & heavy metals; boosts alkalinity; adds essential electrolytes; adds 3-part skin slime replacer; and reduces stress.

Preformed ponds and container gardens also differ from liner ponds in the fact that leaks cannot be fixed. Preformed ponds and barrel liners are impossible to fix if cracked, and must be replaced. Evaporation is also more common and much more noticeable because of the small amount of space. You can, however, follow the same steps when refilling them as you do a natural liner pond. Lastly, over-doing plants and lowering the fish load in your preformed pond or container water garden will help balance the system better!

Pondless® Waterfall

One of the greatest features of the Pondless® Waterfall Filter is that there is very little maintenance. The system can be run 24 hours a day or can be turned off and on when desired. Don't forget to periodically check that there is enough water in the Pondless® Waterfall basin to properly operate the waterfalls. When you hear the pump "gurgling" or sucking air, you know it is time to add water.

General Maintenance The Skimmer

The skimmer is designed to sweep the surface of the water so that it is free from debris. The debris basket or net inside the skimmer is the first filter stage of the skimmer. The basket or net will collect leaves, twigs, seeds, and other debris that falls or blows into the pond. It only takes a few minutes every other week to empty the debris basket or net. More frequent changes will be required during the autumn because of the quantity of leaves falling off the surrounding trees.

It is a good habit during your first season with the pond to periodically check the quantity of debris in the basket or net. This is especially true in the fall. Keep a mental note as to how often your basket or net has to be emptied. It's important that the debris basket or net is not allowed to become too full, as too much debris can reduce the water flow to the pump.

Filter Mat

The filter mat is the second stage of the skimmer. The mat is designed to handle any debris that finds its way past the basket or net. The mat will not need maintenance as frequently as the basket or net, since the basket or net will remove the majority of debris from the water.

The water reaching the pump should be relatively free of any large debris, thanks to the debris net and filter brushes on the skimmer, and if you have a Pondless® Waterfall, the fact that the water has to pass through layers of gravel in the basin.



FILTER MAT: The filter mat should be checked, but not as frequently as the debris basket.



Note: The filter mat may have a slot cut into it so that it fits around the discharge pipe. Install the filter mat correctly so the slot fits around the discharge pipe. Skimmer filter mats are designed to last for about one year. Filter mats may be discolored and appear dirty and old, but will work just fine in your skimmer and BIOFALLS® Filters, or MicroFalls®. Replace old filter mats if they begin to tear or fall apart. Ask your installer or local garden center about replacement filter mats.

The Pump

On occasion, you may see a reduction in the water flow over the waterfall. This could be a sign that it is time to clean the pump intake or the filter screen on the bottom of the pump. This process should take no longer than five minutes. Simply unplug and remove the pump from the skimmer or Pondless® Waterfall

BIOFALLS® FILTER: The filter media only needs to be cleaned once a year.



Note: The Signature Series™ BIOFALLS® filter that comes with the Pondless® Waterfall system does not include filter mats or media bags. There is no need for these items since there is no pond. In addition, Aquascape produces a full line of products and educational materials designed to help you get the most from your new water feature. Ask your installer or local supplier for more information on purchasing these products.

Vault and physically remove any debris found around the impeller, or intake, or bottom of the pump. You may also want to physically remove any debris with your hands that may have found its way to the bottom of the skimmer or Pondless® Waterfall Vault, where the pump sits.

BIOFALLS® Filter

The BIOFALLS® Filter is the starting point of your waterfall. The filter mats and media provide a home for the beneficial bacteria that help clean the pond. It is designed for once-a-year cleaning when used in combination with a Skimmer or Pondless® Waterfall Vault prefilter, ensuring that large debris is filtered

from the water before it reaches the BIOFALLS® Filter.

Most ponds don't require the filter mats or filter media bag in the BIOFALLS® Filter to be cleaned more than once a year. Cleaning them, especially with chlorinated tap water, more often will reduce or kill the beneficial bacteria growing on these filters. Replace old filter mats after several years, when they begin to tear or fall apart. The filter mats can be removed for annual cleaning through the wider opening at the front of the rack.

The Water Level

Every pond will experience evaporation. The amount of water loss due to evaporation depends on waterfall height, water splashing outside the pond, stream length, the amount of sunlight the pond receives, and the temperature of the region where you live.

During the warmest months of the year, most small, residential ponds will need a weekly addition of water to counteract the effects of water loss. During rainy periods, adding water to your pond may not be necessary at all. The water level of the pond can be monitored using the opening of the skimmer mouth as a reference. The ideal water level should be set at about ¾-inch below the top of the skimmer mouth. You can check the water level each time you empty the debris net.

When you notice that the water level is low, simply drop a garden hose into the pond and add the required amount of water. De-chlorinator does not need to be used when adding less than 20 percent of the pond's total water volume.

If your pond is equipped with a water fill valve inside the skimmer, the water level of the pond will be maintained for you. The water fill valve can be connected to the garden spigot on your house or connected to the main line of an underground irrigation system. When the water level in your pond drops, the float on the valve drops also. Water is added through the fill valve until the float rises back to its original position.

Troubleshooting Leaks

If you notice you have to add water on a daily basis, or hear the "hissing" of your water fill valve constantly running, (after properly setting the water level) you may have a leak, most of which occur along the perimeter of the waterfall and stream. These leaks are generally due to the ground settling which causes the water to trickle over the edge of the liner. These leaks can be easily fixed.

LEAKS: Check the liner around the perimeter of the pond – water could be leaking over.



Check the perimeter of the pond, waterfall, and stream for any areas that are wet. This is usually a good indicator that water is leaking over the liner.

Check to make sure any slow moving sections of the stream/waterfall have not become obstructed by leaves, plants, or other debris. This can cause the water to back up and leak over the edge of the liner.

Once you have found the leak, pack additional soil under the liner to raise the edge above the water level. Hide the exposed liner by replacing the gravel and add mulch.

If you have plants growing in your BIOFALLS® Filter, it is common for their growth to displace the water, causing it to flow over the back side of the filter. Simply remove enough of the plants to lower the water level.

Seasonal Care

Fall and Winter Maintenance

In the fall, water is almost always very clear because of the cooler temperatures and the full, lush plants. Enjoy the good water quality! Here are some things that you can do to keep your water garden looking good. Note: Several of the steps do not apply to Pondless® Waterfall systems.

- There may be an increasing number of yellow leaves this time of year, so prune them off all of your plants. Your water lilies – tropical and hardy – should still be going strong, at least until the first heavy frost.
- Stop fertilizing when the weather becomes cooler. This lets the plants know the season is coming to an end.
- When the water temperature is around 55 F° (10° C), stop feeding your fish. Continuing to feed them could cause health problems or death for them, since their digestive systems are beginning to slow down for the winter.
- As leaves fall from nearby trees, you'll probably have to empty the debris net every day to keep up with the influx of leaves. Some of them will undoubtedly sink to the bottom, try to remove as many as you can, however a few left in the pond will give insects and frogs a place to hide over the winter.
- If you leave too much organic matter in your pond, the water may turn brown. If this happens, remove the excess debris and add activated carbon to clear the water.

FALL MAINTENANCE: This is the time to prune the yellow leaves off all of the plants around your pond. The best way to keep up with the falling debris in your pond is to remove it using a skimmer net.



- As it gets colder, your aquatic plants will have all but died for the season. Now you can cut back the dead plant material and remove the tropicals. Cut back the cattails above the water level, or better yet, leave them up to see how magnificent they look in the winter.
- If you're fortunate enough to be where it stays warm all year round, you're set for the winter.
- If you live up north, where the surface of the pond freezes, you'll need to prepare for winter by deciding whether you want to keep your pond running or shut it down.
- To shut your pond down, first unplug your pump and pull it out of the water. The pump should be stored in a frost-free location, submerged in a bucket of water to keep the seals from drying.

FISH: A small circulating pump can be used to keep a hole in the ice for your fish.



- If you have fish, a small re-circulating pump that bubbles at the water surface is necessary to oxygenate the water. In all but extremely low temperatures, the bubbling of the pump will also

BELOW: The ideal water level should be set at about ¾-inch below the top of the skimmer mouth.

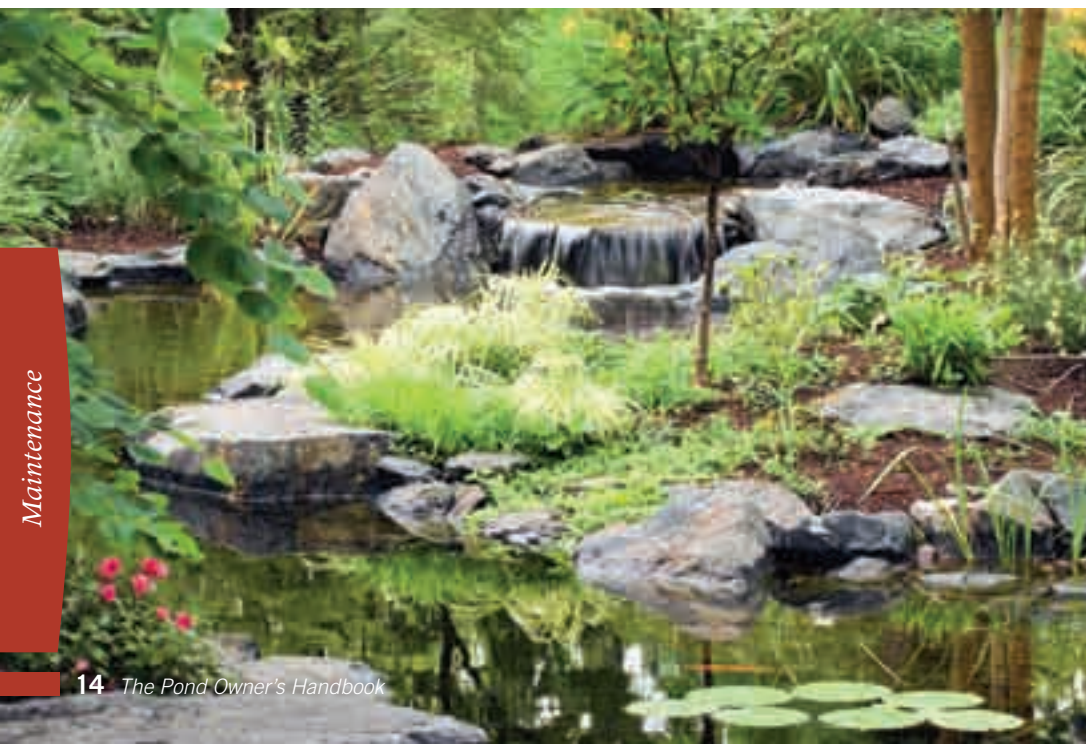

keep a hole open in the ice to allow for a gas exchange, keeping your fish alive. It is not necessary to oxygenate the water or keep a hole open in the ice if you don't have fish.

- If your area experiences long periods of extremely cold weather, you may consider adding a floating de-icer. Controlled by a thermostat, the unit only runs when the water temperature is at or below freezing, heats the water to just above that, and then shuts off again. Ask your installer or local supplier for products to help your pond during the winter.



Recommended spring maintenance products: EcoSystems® EcoStarter™ Plus and EcoSystems® EcoTabs™.

- If you use a floating de-icer, place it away from the bubbler. The movement of the water can move the heated water away from the de-icer, making it run more than necessary.

- You can also choose to keep the waterfall running. This will require a little babysitting to make sure an ice dam does not form, which could cause water to run out of the Pondless® Waterfall/ Pond basin. You will also still need to replace water loss so the pump can continue to function properly (see "The Water Level" on page 14). This extra effort during the winter will reward you with the most beautiful ice formations and patterns around the falls and streambeds.



The most important thing is to have fun with your water feature all year long. Keep some of these key maintenance issues in mind, and it will be smooth sailing. In the meantime, stay warm!

Spring Maintenance

Spring is simply the most exciting time of year. As things slowly awaken from their winter hibernation, there are some things that you can do to make sure your water feature gets off to a good start this spring.

Does your water feature need a full clean-out this season or does it just need to be tidied up a little? There are a couple of things that you can look for to help you decide. First, if there is a layer of "crud" at the bottom of the pond and the water is dark in color, it would be a good idea to do a full clean-out.

On the other hand, if there is just a small amount of debris that you can stir up and capture with a net and the water looks clear, a little tidying up is all that's in order. Plan on spending a half to a full day to complete a pond cleanout. A Pondless® Waterfall will take considerably less time.

Here's what you'll need to get started:

- A clean-out pump with approximately 25 ft. of discharge hose.
- A high-pressure nozzle for your garden hose, or a power washer.
- Garden shears for trimming plants.
- A child's swimming pool or a similar sized container to hold fish and any other critters you find during the clean-out.
- A net or something similar to place over the fish container to keep them from jumping out.
- Two five-gallon buckets to collect leaves and debris.
- A fish net.
- EcoSystems® EcoStarter™ Plus water conditioner to remove chlorine and chloramines prior to putting fish back.
- EcoSystems® EcoTabs™ fertilizer tabs.

The best time to perform a pond clean-out is the early spring, before your water garden completely awakens from its winter dormancy – ideally before the water temperature in the pond creeps above 55° F. If a clean-out is performed when the water is warmer, after bacteria colonies form, the balance of the ecosystem will again be thrown off and your pond will go through another "green

phase" before the bacteria colonies re-establish themselves again.

Drain the Pond/ Pondless® Waterfall

Place the clean-out pump in the deepest point of the pond or in the Pondless® Waterfalls Snorkel in order to remove the water.

Drain the water into the surrounding landscape. Be sure to relocate the pipe two or three times to allow the water to seep into the ground and not flood the yard.

If you have fish, use some of this pond water to fill up the holding pool. The fish can be removed from the pond using a net once the water is low enough so you can easily catch them.

Don't keep the fish in the holding pool for more than several hours. Keep them in a shady spot with a net over the top of the pool to prevent them from jumping out.



Don't Overdo the Cleaning

Rinse the inside of the pond. You can also use a pressure washer to help remove debris from the rocks and gravel.

Don't try to scrub all of the algae away. Some algae on the rocks will prove beneficial in developing your ecosystem. For an average size pond (11' x 16') this should take around 15 minutes.

Use the gentle stream from a garden hose to rinse the rocks and gravel. Start at the top and work your way down to the bottom. Periodically turn the clean-out pump on to remove the dirty water. You can discontinue the periodic pumping once the water rinsing down to the bottom begins to look clear. Remove the pump and begin filling the pond.

Cleaning the Filters

Remove any debris from the bottom of the skimmer and Snorkel™ Vault. This can be done by hand or by using the cleanout pump.

Remove the media nets and filter pads from the BIOFALLS® Filter. (Not included with the Pondless® Waterfall). If you have the optional drain kit attached to your Signature Series™ BIOFALLS® Filter, you can open up the valve and rinse the media and filters. Once the filters have been removed rinse them free of accumulated debris.

The filter media and mats can be put back into place and the waterfall pump can be reattached in the skimmer or Snorkel™ Vault.



Putting Your Fish Back Into Their Clean Home

Your pond clean-out is now done and it's time to put your fish back into their home. Once your pond is half full, you can perform these steps to safely place your fish back in the pond:

- If you're on city water, it's imperative that you add a de-chlorinator to the water so it is safe for fish.

- Dip a five-gallon bucket, or similar sized container, in the holding tank and fill it with water.

- After you've caught a fish, place it in the bucket and set the buckets in the clean water.

- After about 15 minutes, periodically begin splashing some pond water into the bucket.

- By now, the temperature of the pond and the bucket water should be close to the same. You are ready to spill the fish into their spring-cleaned home.

A FEW ALGAE FACTS

Types of Algae:

The two types of algae that most water gardeners experience are suspended algae and filamentous algae. Suspended algae consist of millions of microscopic algae floating throughout the

water. This causes the water to turn green or "pea soup" color. Filamentous, or string, algae forms long and short hair-like strands, attaching itself to rocks, gravel, plants, or any surface area it can find in the pond.



STRING ALGAE

The Annual Pond Cycle: Most pond owners will notice a similar algae pattern in their pond, throughout the year. The cooler temperatures of early spring and late fall typically bring increased algae growth. Don't be discouraged if your pond turns "pea soup" green or you have string algae problems during this time. Be patient as the pond and ecosystem tries to get itself balanced. This lack of balance results in excess algae. But as the water warms and the ecosystem becomes more active, the algae will be reduced. Some ponds take longer than others do, but your pond will once again be clear and string algae will noticeably diminish as the summer approaches.

Algae Control

Algae control is often considered to be the biggest headache in water gardening. There are different view points as to how algae should be controlled or eliminated – naturally, artificially, or a combination of the two.

Artificial Algae Control

If you have a pond that's suffering from green water and you can't see



your fish, you may need to use a UV filter in order to clear up your water. A UV sterilizer kills a lot of things – parasites, beneficial bacteria, insects, and most other microscopic organisms living in the water.

However, the UV filter is totally ineffective when it comes to string algae and may even inadvertently promote an increasingly larger string algae bloom.

The Natural Way

Mother Nature's prescription for algae control is simple – make sure you have a balanced ecosystem! Many pond problems are symptoms of imbalances. There are several products that can help keep your pond in balance, in case it needs a little boost. We like to refer to them as complements to Mother Nature.

TOP 10 METHODS TO BALANCE YOUR ECOSYSTEM

- 1 **Aquascape Beneficial Bacteria:** Contains bacteria and enzymes that are specifically blended to be effective at reducing sludge, uneaten fish food, fish waste, and excess nutrients that cause poor water quality and clarity. Blended and tested to produce maximum results in ornamental ponds.
- 2 **Aquascape EcoBlast™:** EcoBlast™ is Aquascape's #1 treatment for breaking down debris. It is *fast-acting* and works on contact. It is not temperature sensitive and can be used during cold temperatures. Safe for fish.
- 3 **Aquascape S.A.B.™:** This is formulated to help reduce pond maintenance and promote the growth of beneficial bacteria and enzymes. S.A.B.™ will assist in the breakdown and reduction of debris in the stream, waterfalls, and pond.
- 4 **Plants:** Since plants directly compete with algae for nutrients and sunlight, they are probably the most important addition to your pond. Add a wide variety of plants to your pond. This not only creates a natural look, but also will help reduce the algae in different areas of your pond.

Place water hyacinth and water lettuce in your BIOFALLS® Filter. These floating plants reproduce rapidly, using up enormous amounts of nutrients. A stick placed across the front of the BIOFALLS® Filter will prevent the plants from flowing over the front of the waterfalls and into the pond.

Plenty of bog and marginal plants should be added to the pond. Plants such as cattails and iris take up large quantities of nutrients. They are hardy and will be back each spring to help you balance your pond.
- 5 **Physical Removal:** Physically remove clumps of string algae if it begins to overtake the pond. Pull or cut away the algae where it is attached. Think of it as "weeding the pond."
- 6 **Koi:** Adding koi over 10 inches in length will greatly reduce string algae. The koi, if not overfed, will graze on the string algae in the pond. Only feed the fish what they can consume within a few minutes. Fish food that is not eaten by fish will decompose in the pond and increase nutrient levels.
- 7 **Fix Leaks:** Tap water can have an abundance of nutrients in it. Continually adding large quantities of tap water to compensate for a leak can actually promote algae growth. Fix leaks when they are discovered.
- 8 **Control Run-Off:** Never use lawn fertilizer or insecticides on trees around your pond or on areas of your property that will drain toward your pond. Lawn fertilizer and insecticides will cause large algae blooms, as well as severely threaten the aquatic life inside your pond.
- 9 **Remove Debris:** Keep your pond free of debris. Don't let the skimmer debris net overflow with leaves. Decaying debris in the skimmer will contribute to unwanted nutrients.
- 10 **Have Patience:** It takes time for the bacteria to establish itself and colonize to the point of being a benefit to your pond. In general, a new pond can take anywhere from two to six weeks for the bacteria population to reach this point.

Pump Electrical Set-up and Maintenance

Electrical

Please read the following guidelines for proper pump installation and performance. Failure to follow these guidelines may void the pump's liability warranty.

- It is required that a ground fault circuit interrupter (GFCI) be installed for the water feature by a **qualified electrician**.
- It is recommended that a dedicated outlet be provided for the water feature.
- Please have the electrician refer to the pump's electrical specifications for the proper electrical operating range of the pump. The pump will need to be run within these electrical parameters to ensure proper pump performance and best possible lifespan.
- Electrical testing should **also** be completed under **full load** at the outlet. Make sure all other electrical devices that will be in used in and around the water feature are plugged in and in operation during full load testing phase. The pump should still fall within the minimum and maximum voltage and ideal amperage range during full load testing.
- Hardwiring the pumps is not recommended due to complications caused when servicing or replacing the pump.
- Please have the qualified electrician contact the water feature installer or place of purchase with any questions related to the pumps electrical requirements. Improperly installed and/or faulty electrical causing the pump to fail will void the pump's 2 year limited liability warranty.

Extension Cord

- Extension cords should only be used to test the pump in the new water feature.
- Using an extension cord, especially one over 25 feet long, may cause irregular power to the pump. The



voltage and amperage supplying the pump may be affected, causing performance problems with the pump, and possibly reducing the pump's lifespan.

Maintenance

Proper maintenance of the water feature will also ensure the best possible lifespan of the pump. Please make sure to consider the following:

- Do not allow the filters to become clogged with debris and sediment. Conduct regular cleaning and seasonal maintenance according to your owner's manual.
- Keep water flowing freely to the pump by routinely cleaning the skimmer debris net and filter mat. Be sure to maintain proper water level in the water feature. Avoid allowing the pump to run dry or operate in low water level situations.
- Inspect and remove large debris, such as mulch, sticks, small pebbles, etc from the bottom of the Skimmer, Snorkel™ Vault, or sump basin in order to prevent the pump from becoming clogged and possibly damaged.

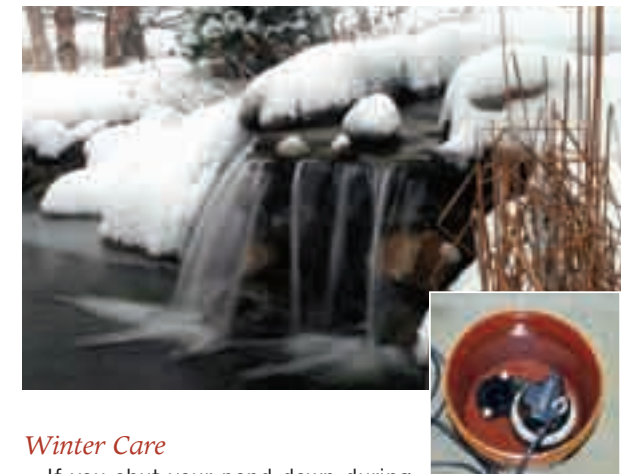

Winter Care

If you shut your pond down during the winter season we recommend removing the pump from the filter and storing in a bucket of water in a frost free location. The water will help maintain the life of the seals on the pump while in storage. Please note that the pump, depending on how long it has been out of operation over the winter may need to be "kick-started." To test, plug the pump into the electrical outlet prior to installing the pump back in the skimmer and visually inspect if the pump's impeller is spinning. If the pump's impeller does not start spinning on its own unplug the pump and use a screw driver or similar device to assist the impeller.



FINDING PUMP PROBLEM: Make sure skimmer net and filter pad are not clogged.

pump. Hopefully, all of the pumps you install will perform for a number of years without a problem. You do, however, want to be prepared for the unusual case when a relatively new pump is experiencing problems. How can the pump not be working? Odds are the pump is actually fine, there is just some troubleshooting that needs to be done.

The troubleshooting steps listed will help you quickly identify and solve the problem with a failed pump.

Proceed With the Following Actions Until the Problem Is Found.

- First of all, is the pump receiving water? This sounds like an obvious question, but we have had clients call and state that their pump is not working only to find that they haven't added water to the pond in the past few weeks and the skimmer ran dry. The pump in this situation may actually be running, but just not receiving enough water. A lot of times you can actually hear the "hum" or "gurgle" of the pump while it's in the skimmer.
- Make sure nothing is blocking the flow of water to the pump, such as large boulders, debris blocking the front of the skimmer opening,

a clogged skimmer net, or clogged skimmer filter mat that has not been emptied or cleaned in a long time.

- The pump may be vapor locked. This term sounds complicated, but it simply means that air is trapped in the volute of the pump. The pumps are designed to push water, not air... so an air bubble gets trapped, and the pump becomes vapor locked. In this situation the impeller is basically spinning, but water is not being pushed. Listen to see if you hear the hum of the pump. A vapor lock can be fixed by tilting the pump to allow the air to escape from the intake. You may even be able to accomplish this without disconnecting the fitting on pump.
- It is also effective to check and see if the electrical supply is operating properly. Premature pump failures can occur due to faulty electrical. For example, pumps hooked up to extension cords may cause potential problems. While this electrical setup usually works for testing the pump soon after the water feature is built, it is not recommended for permanent installations, and may end up causing the pump to fail.

Plug pump in, and if the impeller begins spinning the lubrication will be reintroduced between the seals and the pump should start on its own. The pump can now be installed back into the water feature.

Troubleshooting Pump Problems

The pump can be called the "heart" of the pond. Without it, the relaxing, rushing sound of the water over the rocks would not exist. The fish, and the filtering bacteria in the BIOFALLS®, also depend on the pump to provide fresh, oxygenated water. Thankfully, all of the pumps Aquascape carries should provide years of maintenance-free service in the pond.

Regardless, sooner or later you will have to go out and replace the



- Check the electric box to see if the safety breaker on the ground fault circuit interrupter (GFCI) has tripped. The proper electrical setup for the pond should include a GFCI outlet. The GFCI's responsibility is to shut the power down if it senses an electrical problem. The GFCI is a safety device installed to protect people from receiving a shock in case of an electrical malfunction. GFCI's are very sensitive and can sometimes trip during a thunderstorm or a power surge. Reset the breaker if it has tripped.
- Unplug the pump and disconnect the union fitting found at the top of the check valve. The water will back-flush from the BIOFALLS® back into the skimmer. This will help flush out any possible clogs along the length of the pipe.
- Pull the pump out of the skimmer and inspect the intake on the pump for any lodged debris. Aquascape pumps are capable of handling solids and debris up to a reasonable size, typically 5/8". On some occasions, debris may

become lodged in the impeller (housing) of the pump. This could possibly seize up the impeller, or restrict the flow causing the pump to stop operating properly. Thoroughly check the pump intake, including the area above the impeller where small debris, such as gravel, may be trapped.

- Plug in the pump after inspecting it for debris, and see if the impeller spins.
- If the impeller does not spin, unplug the pump and try to assist it by using a screwdriver or similar tool to give it a little kick start. On some occasions, the impeller may seize up and not spin. This sometimes happens after the pump has been out of operation for a period of time (such as over the winter). Hopefully, the pump will then begin to operate after it is plugged back in. Once it starts back up on its own, you'll want to unplug the pump again, wait a few seconds, and plug it back in. The impeller should begin to spin without assistance this time.
- If you still have no luck, bring the pump over to a different electrical

receptacle on the property, specifically one that contains a GFCI breaker, and see if the pump operates. This will tell us if the pond's electrical supply is bad, or if there is something internally wrong with the pump. If the pump trips this GFCI, then there is definitely something wrong with the pump, and it should be replaced. However, you'll want to have a qualified electrician come out and check the pond's electrical setup if the pump runs without a problem on another outlet.

Hopefully, through these steps, you have found the source of the problem and corrected it. You will most likely have to replace the pump if you are still having problems getting proper performance.

Warranted Pumps

All of Aquascape's pumps are covered under warranty (length of warranty depends on the pump model). This warranty covers any mechanical failure within the pump that causes it to perform

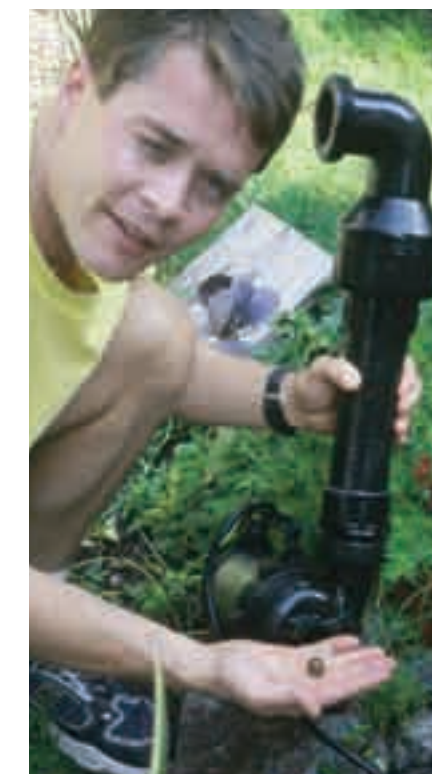
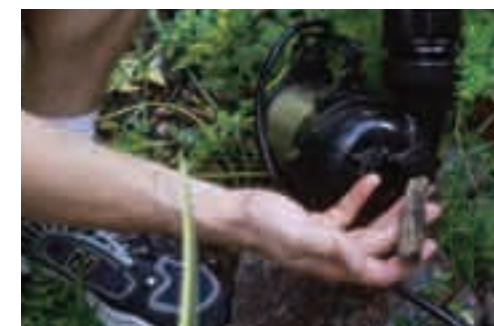

improperly. Please keep in mind that this warranty does not cover damage or defects due to mishandling, improper installation, improper electrical set-up, or debris damaging the pump or impeller.

There are typically two reasons that most submersible-style pumps fail.

- The first is due to the seals on the pump failing. This allows moisture to enter into the pump. The GFCI will sense this moisture and will trip the breaker, cutting off the electrical supply to the pump.
- The second reason may be due to bearing failure, which would explain the problems with the impeller failing to spin when the pump is plugged in. ■



Aquascape continues to work with our engineers and pump manufacturers to reduce our return rates and further increase the lifespan of our pumps. Our ultimate goal is to furnish a pump that will provide years of trouble free service!

TYPICAL PARTS OF A PUMP

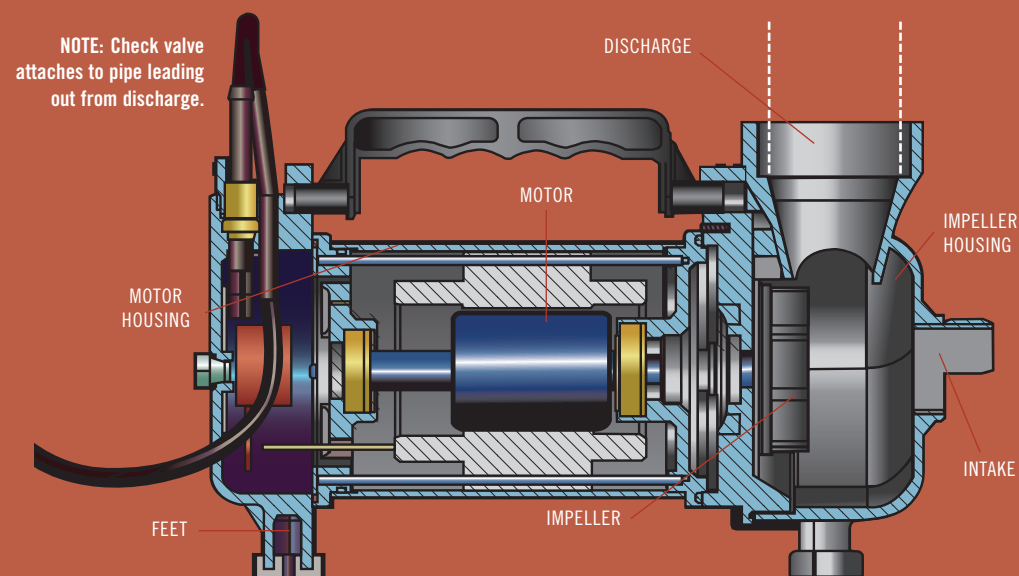

References

CALCULATIONS

Approximate Gallons of Water in a POND
 Length x Width x 80% x Avg. Depth x 7.48 = total gallons

**The basin takes up approximately 80% of the actual SQ. FT.*

Approximate Gallons of Water in a STREAM
 (Length x Width x .25 (Depth) x 7.48) = Gallons in the stream.

**You need 2x the amount of water in your basin.*

Approximate Gallons of Water in a PONDLESS® WATERFALL BASIN

With Stone
 Length x Width x Depth x 2.2 = Gallons in the Basin

With Large Matrix
 Length x Width x Depth / 4.3 = Number of matrix used
 Number of matrix used x 32 = Gallons in the Basin

With Small Matrix
 Length x Width x Depth / 2.3 = Number of matrix used
 Number of matrix used x 17 = Gallons in the Basin

Electrical Consumption/Conversions
 Amps x Volts ÷ 1,000 x .10 (kw/perhour) x 24 hrs x 30.4 days = Monthly Cost
 Watts = volts x amps Amps = watts ÷ volts

Rock Calculation for the POND
 Length x Width ÷ 40 = Tons of boulders **Using a 1:2:1 ratio.*

For every (1 TON) of 6"-12" rock, Get (2 TON) of 12"-18" and (1 TON) of 18"-24"

Quantity of BOULDERS used in a STREAM
 For Every 10' of STREAM = (1 ½ TON) using 1:2:1 RATIO from above

Quantity of GRAVEL Used in the POND
 Pond Gravel = 30% total tons of pond boulders

Quantity of GRAVEL Used in the STREAM
 Stream Gravel = 30% total tons of STREAM Boulders

Small MicroPond/ D.I.Y. Rock Calculation for the POND
 Length x Width ÷ 65 = Tons of boulders

Small MicroPond / D.I.Y. Quantity of Boulders used in a STREAM
 For Every 10' of STREAM = (½ TON) 6"-12" & (½ TON) 12"-18"



INFORMATION RESOURCES

Websites:

- www.aquascapeinc.com
- www.watergardening.com
- www.koivet.com

Books:

- The Hobbyist's Guide to Pond Plants, The Pond Guy™ Publications, St. Charles, IL
- The Ecosystem Pond, The Pond Guy™ Publications, St. Charles, IL
- Water Garden Lifestyles, The Pond Guy™ Publications, St. Charles, IL
- Container Water Gardening for Hobbyists, The Pond Guy™ Publications, St. Charles, IL

To purchase books, see your local contractor/retailer, or visit www.aquascapeinc.com.

HARDINESS ZONE CHART

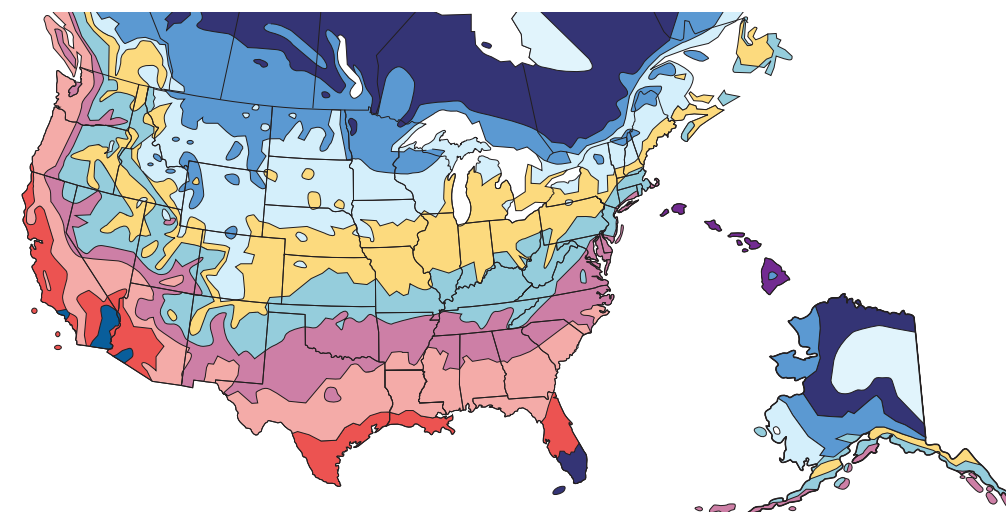

Range of average annual minimum temperatures for each zone.

- Zone 1 below -50° F
- Zone 2 -50° to -40°
- Zone 3 -40° to -30°
- Zone 4 -30° to -20°
- Zone 5 -20° to -10°
- Zone 6 -10° to 0°
- Zone 7 0° to 10°
- Zone 8 10° to 20°
- Zone 9 20° to 30°
- Zone 10 30° to 40°
- Zone 11 above 40°

Water Garden Resources

Books



ASK YOUR LOCAL WATER GARDENING SUPPLIER ABOUT OUR BOOKS TODAY OR SEARCH FOR THEM AT WWW.AQUASCAPEINC.COM

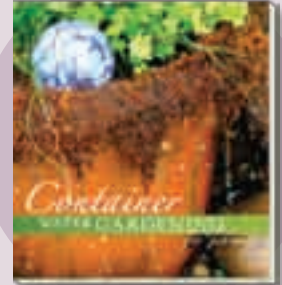

SIGN UP FOR OUR FREE MONTHLY E-NEWSLETTER AT WWW.AQUASCAPEINC.COM

Websites

WWW.WATERGARDENING.COM



Join hundreds of like-minded water gardeners at www.watergardening.com, a free online water gardening community for hobbyists and professionals alike. You can share photos, videos, articles, and make new friends.

WWW.AQUASCAPEINC.COM



Everything you need to know about water gardening is readily available on the web at www.aquascapeinc.com.



www.aquascapeinc.com

Item #29930

©2010 Aquascape, Inc. All Worldwide Rights Reserved